



LED LUMINAIRES

LED Flood Series



High Performance
LED Technology



IP65 Rated



50,000 Hour Life



DLC QPL
Listed Premium

LED Flood Series luminaires create bright consistent lighting for outdoor applications in a small, lightweight footprint



Small Footprint

**Up to 88% Energy Savings
vs. HID**

5-Year Limited Warranty

Applications:

- School
- Park
- Convenience Stores
- Gas Stations
- Common Walkways

Markets:

- Commercial
- Industrial



Contact Your Customer Care Specialist
For Pricing, Orders And Technical Support.

800.677.3334 **www.halcolighting.com**

LED Flood Series

Product #: _____ Type: _____

Project: _____ Date: _____

Comments: _____ Initials: _____

Specifications

- Operating temperature range is -40°F (-40°C) to 104°F (40°C)
- Die-cast aluminum housing
- Textured architectural bronze powdercoat finish
- Silicone gaskets protect against dust, corrosion, dirt and insects
- Clear polycarbonate lens (NEMA type 6 distribution)
- Removable 1/2" threaded plugs with O-rings for photocell provision (FL2 only)
- Voltage sensing 120-277V dimmable driver (FL2 only)
- UL Listed for wet locations
- IP65 rated

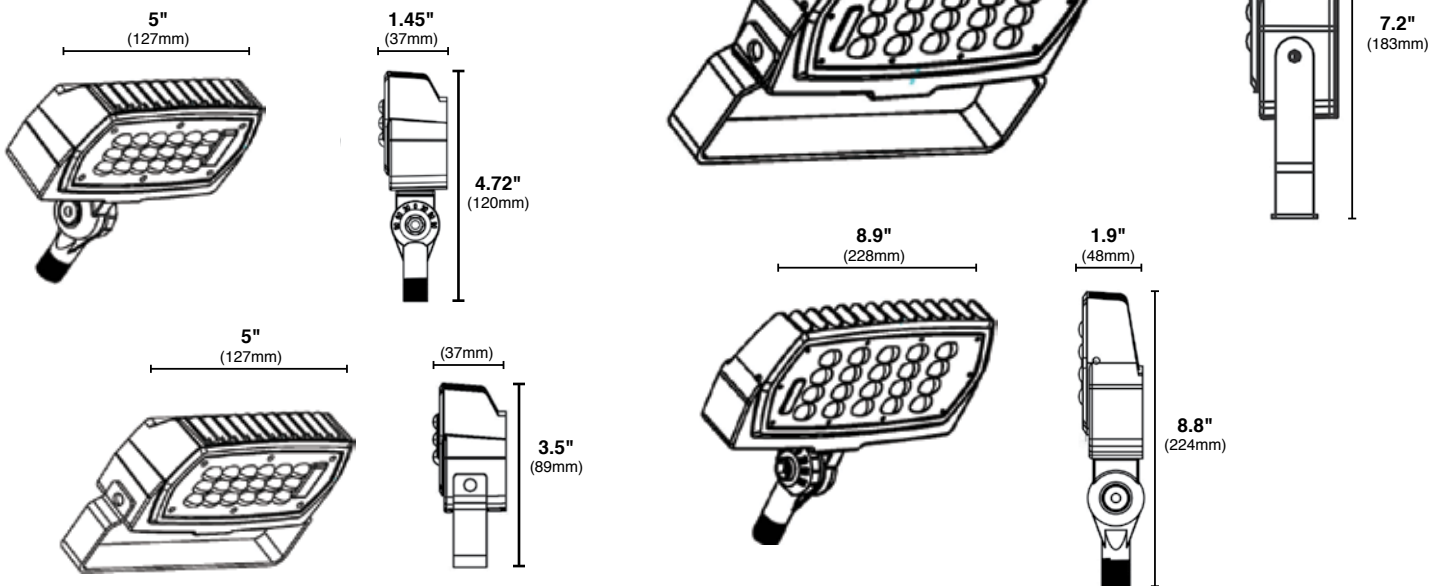

Ordering Information



Watt	Product #	Product Code	Volts	Color Temp.	CRI	Lumens	Useful Life*	Pkg. Qty.	Dimmable	DLC	Equivalent Wattage
12	99875	FL1/CL12BZ50/KN/LED	120-277V	5000K	70	1474	50,000	1/24	No	Yes	100W MH
12	99876	FL1/CL12BZ50/YK/LED	120-277V	5000K	70	1474	50,000	1/24	No	Yes	100W MH
28	99877	FL2/CL28BZ50/KN/LED	120-277V	5000K	70	3307	50,000	1/12	Yes	Yes	150W MH
28	99878	FL2/CL28BZ50/YK/LED	120-277V	5000K	70	3307	50,000	1/12	Yes	Yes	150W MH
48	99879	FL2/CL48BZ50/KN/LED	120-277V	5000K	70	5562	50,000	1/12	Yes	Yes	175W MH
48	99880	FL2/CL48BZ50/YK/LED	120-277V	5000K	70	5562	50,000	1/12	Yes	Yes	175W MH

* Useful Life is defined as the point in time at which the lamp will maintain at least 70% of its initial lumens. The lamp will continue to burn past this point, but at decreased light levels.
 Warranty – Commercial / Industrial: This product is warranted for 5 years from the date of purchase.

Accessories (Field Installable)

Product #	Product Code	Description
10114	PCS/WP	Photocell 110-130V
99811	PTF/FL	Post Top Fitter Flood for Knuckle Mounts only
99813	HDGS/FL	Heavy Duty Ground Stake for Knuckle Mounts only



Accessories include hardware.

Warranty – Commercial / Industrial: This product is warranted for 1 year from the date of purchase, based on 10 hours of use per day.