



COMBODRIVE X3

PLUG & PLAY OR LINE VOLTAGE COMPATIBLE

KT-LED13T8-48G-850-X3 T8 LED LAMPS

DESCRIPTION

13W T8 4' LED | 5000K | >83 CRI |

Single- or Double-ended Wiring | Ballast and Line-Voltage Compatible



LAMP TYPE: Linear
BULB TYPE: T8 LED
BASE TYPE: G13 (Medium Bi-Pin)
WATTAGE: 13W
COLOR TEMPERATURE: 5000K
COLOR RENDERING INDEX (CRI): 83
WARRANTY: 5 Years



PRODUCT FEATURES

- Plug & Play application: Compatible with most instant- and programmed-start electronic T8 ballasts
- Bypass ballast application: Runs on 120–277 line voltage
- Can be used with step down transformer for 480V to 120V/277V
- Frosted lens eliminates pixelation
- Environmentally friendly: No mercury used
- 50,000+ hour lifetime
- Instant startup
- Operating temperature: -20°C/-4°F to 45°C/113°F
- Suitable for dry and damp indoor locations
- UL Listed

OPERATING SPECIFICATIONS

Catalog Number	CCT	CRI	Bare Lamp Wattage	Instant-Start Ballast-Compatible Application						Line-Voltage Application			Max THD	Power Factor	
				Input Voltage	System Wattage*			Initial Lumens*			Input Voltage	Lamp Wattage			Initial Lumens
					0.78BF	0.88BF	1.18BF	0.78BF	0.88BF	1.18BF					
KT-LED13T8-48G-850-X3	5000K	83	13W	Ballast dependent	13.5W	15.5W	23.0W	1750 lm	1950 lm	2700 lm	120–277V	13W	1950 lm	20%	>0.9

* Nominal values. Actual values may vary depending on electronic ballast used.

SPECTRAL DISTRIBUTION

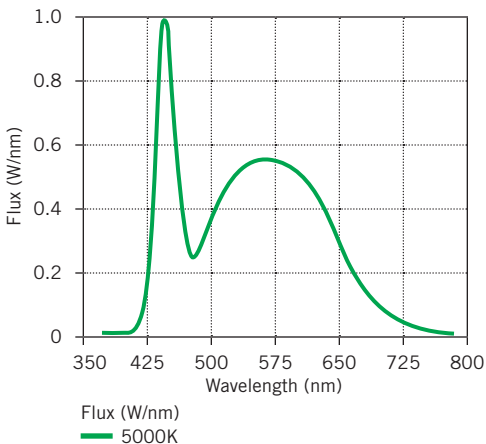

POLAR CANDELA DISTRIBUTION

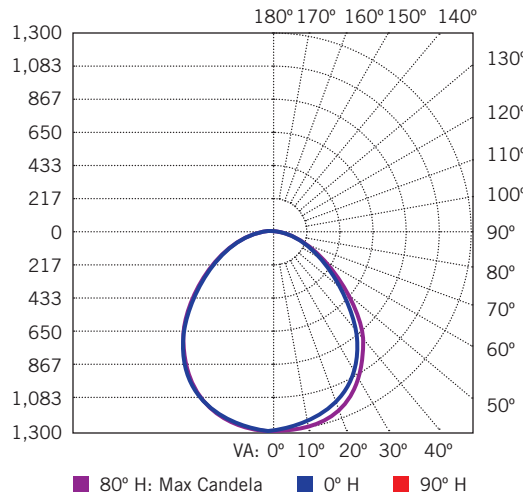

PHOTOMETRIC CHARACTERISTICS

CCT	CRI	Luminous Flux	Efficacy	Beam Angle
5000K	83	1950 lm	150 lm/W	160°

RATED LIFE

L70 (Hours)
50,000

Maximum Candela = 1299.2
Located at Horizontal Angle = 80°,
Vertical Angle = 4°

KT-LED13T8-48G-850-X3

T8 LED LAMPS

INSTALLATION INSTRUCTIONS

DIRECT REPLACEMENT (WITH EXISTING BALLAST)

1. Turn power off.
2. Remove lens or diffuser, if applicable.
3. Remove existing fluorescent lamp(s) from the luminaire.
4. Install the LED replacement lamp(s), one lamp for each fluorescent lamp removed*.
5. Replace lens or diffuser back in place, if applicable.
6. Turn power back on.

* **Warning:** Check Keystone's *Ballast Compatibility List* before installation

BY-PASS REPLACEMENT (WITH BALLAST REMOVED)

- A. Disconnect power from fixture.
- B. Remove fluorescent lamps.
- C. Remove lens and wiring compartment, if applicable.
- D. Cut all wires connected to ballast (see **Figure A: Typical Ballast Configurations**).
- E. Identify what type of lamp holders are in fixture: non-shunted lamp holders or shunted lamp holders (see **Figure B: Lamp Holder Types**). Double-ended wiring installations of Keystone Combo Drive X3 tubes can be used with shunted G13 or non-shunted G13 lamp holders with instructions to externally shunt.

FIGURE A Typical Ballast Configurations

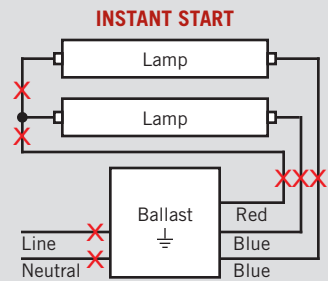
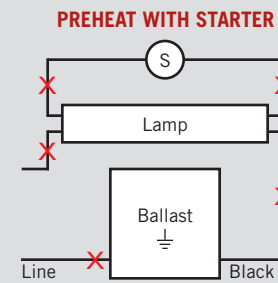
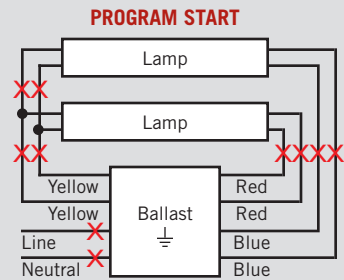

CAUTION: Instant start ballasts have shunted lamp holders.

FIGURE B Lamp Holder Types

TYPICAL NON-SHUNTED LAMP HOLDER

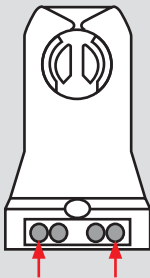

Connect wires directly to these terminals

TYPICAL SHUNTED LAMP HOLDER

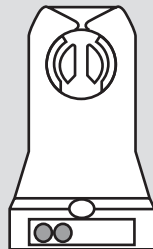

Internal shunt

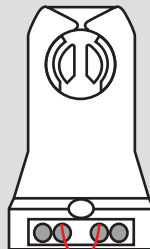

External shunt

Caution: For single-ended wiring use *only* non-shunted lamp holders.

For Single-ended wiring, do not install product in a fixture with shunted lamp holders (found in all fixtures using instant start ballasts). If the current lamp holders are shunted, remove them and replace them with non-shunted lamp holders. Make new connections directly to terminals as indicated above.

Keystone can provide any style replacement lamp holders. Call us at 800-464-2680.

FIGURE C Direct Drive LED Tube Connection Pins

SIDE A

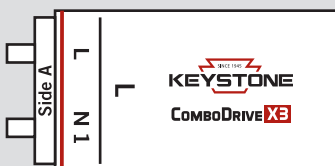

SIDE B

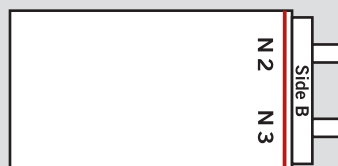

KT-LED13T8-48G-850-X3

T8 LED LAMPS

WIRING DIAGRAMS

DOUBLE-ENDED LINE VOLTAGE WIRING

Single lamp

1. Follow steps A–C (see **By-Pass Replacement (with ballast removed)**, on page 2).
2. Cut all existing connections to ballast and remove ballast (see **Figure A**, on page 2, for typical ballast configurations).
3. Connect line voltage AC to both pins on Side A of the lamp (marked L and N1) on the endcap as shown below; on Side B, connect line neutral AC wire to pins marked N2 and N3 on the endcap as shown below (see **Figure C**, on page 2, for Direct Drive LED tube connection pins).

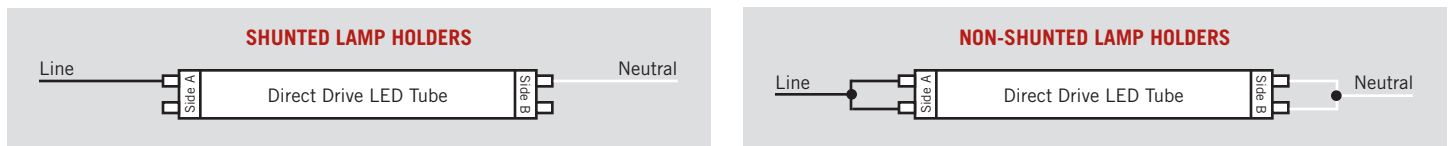

4. Complete all electrical connections with appropriate connectors/wire nuts as needed, per all local and national electrical codes.
Note: there should not be any exposed wires from sockets left unconnected.
5. Replace wiring compartment cover.
6. Ensure that installed lamp is wired to line and neutral in the lamp holder and that lamp is facing proper direction for illumination.
7. Install lens or diffuser, if applicable.
8. Apply power to fixture and check for illumination.

Multiple lamps

1. Follow steps A–C (see **By-Pass Replacement (with ballast removed)**, on page 2).
2. Cut all existing connections to ballast and remove ballast (see **Figure A**, on page 2, for typical ballast configurations).
3. Connect the terminals of the first lamp to the matching terminals of the second lamp with line and neutral wires. Continue daisy-chain connection for each additional lamp as shown below.

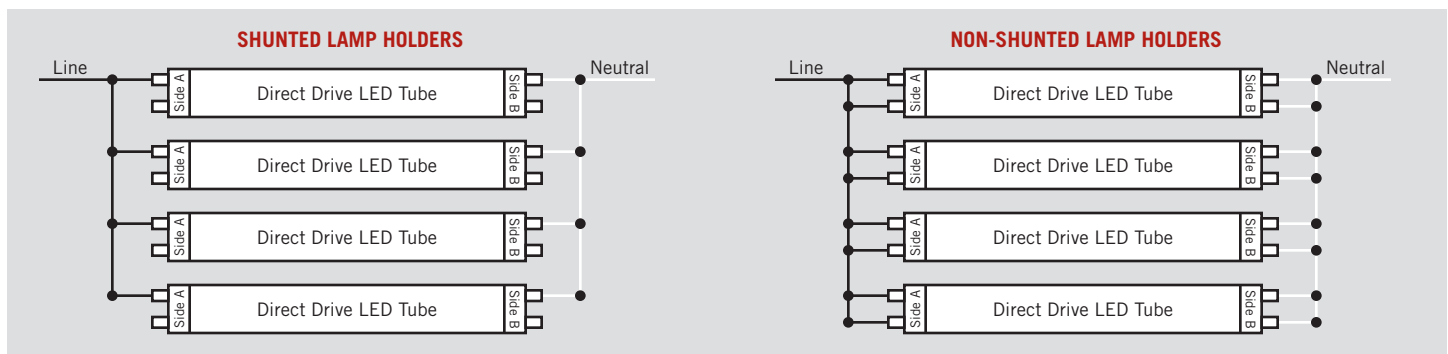

4. Complete all electrical connections with appropriate connectors/wire nuts as needed, per all local and national electrical codes.
Note: there should not be any exposed wires from sockets left unconnected.
5. Replace wiring compartment cover.
6. Ensure that installed lamp is wired to line and neutral in the lamp holder and that lamp is facing proper direction for illumination.
7. Install lens or diffuser, if applicable.
8. Apply power to fixture and check for illumination.

(wiring diagrams continued on next page)

KT-LED13T8-48G-850-X3

T8 LED LAMPS

WIRING DIAGRAMS (continued)

SINGLE-ENDED LINE VOLTAGE WIRING*

Note: For single-ended wiring installations, power is applied *only* to endcap labeled Side A.
Do NOT apply power to Side B.

Single lamp

1. Follow steps A–C (see **By-Pass Replacement (with ballast removed)**, on page 2).
2. Cut all existing connections to ballast and remove ballast (see **Figure A**, on page 2, for typical ballast configurations).
Note: Single-ended wiring requires non-shunted lamp holders (see **Figure B**, on page 2, for lamp holder types).
3. On Side A of lamp holder, connect line voltage AC wire to pin marked L and connect line neutral AC wire to pin marked N1 on the endcap as shown below (see **Figure C**, on page 3, for Direct Drive LED tube connection pins). Do not connect AC wires to Side B.

***Caution:** Use only non-shunted lamp holders for single-ended wiring installations. Do not perform single-ended wiring installation of product in a fixture with shunted lamp holders (found in all fixtures using instant-start ballasts). If the existing lamp holders are shunted and single-ended wiring is desired, remove and replace them with non-shunted lamp holders (or remove the external shunt, if applicable). Make new connections directly to lamp holder terminals as shown on this page).

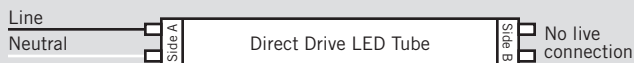

4. Complete all electrical connections with appropriate connectors/wire nuts as needed, per all local and national electrical codes.

Note: there should not be any exposed wires from sockets left unconnected.

5. Replace wiring compartment cover.
6. Ensure that installed lamp is wired to line and neutral in the lamp holder and that lamp is facing proper direction for illumination.
7. Install lens or diffuser, if applicable.
8. Apply power to fixture and check for illumination.

Multiple lamps

1. Follow steps A–C (see **By-Pass Replacement (with ballast removed)**, on page 2).
2. Cut all existing connections to ballast and remove ballast (see **Figure A**, on page 2, for typical ballast configurations).
Note: Single-ended wiring requires non-shunted lamp holders.
3. Connect the terminals of the first lamp to the matching terminals of the second lamp with line and neutral wires. Continue daisy-chain connection for each additional lamp as shown below. **Note:** Do not connect any wires to Side B of lamp holder.

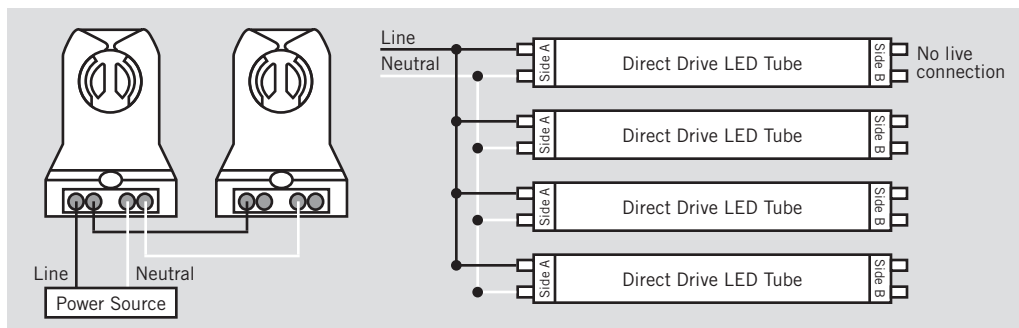

4. Complete all electrical connections with appropriate connectors/wire nuts as needed, per all local and national electrical codes.

Note: there should not be any exposed wires from sockets left unconnected.

5. Replace wiring compartment cover.
6. Ensure that installed lamp is wired to line and neutral in the lamp holder and that lamp is facing proper direction for illumination.
7. Install lens or diffuser, if applicable.
8. Apply power to fixture and check for illumination.



COMBODRIVE X3
PLUG & PLAY OR LINE VOLTAGE COMPATIBLE

KT-LED13T8-48G-850-X3

T8 LED LAMPS

PHYSICAL CHARACTERISTICS

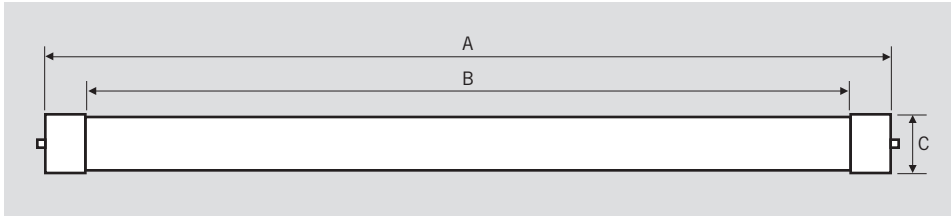

LAMP DIMENSIONS

A (Body Length)	47.15"
B (Illuminated Length)	42.63"
C (Diameter)	1.10"

NOMINAL LENGTH: 48"

BASE TYPE: G13 (Medium Bi-Pin)

ORDERING INFORMATION

ORDER CODE	PACK QTY.	EASY CODE	UPC
KT-LED13T8-48G-850-X3	25	MOF-22	843654129464

CATALOG NUMBER BREAKDOWN

KT-LED13T8-48G-850-X3

1 2 3 4 5 6 7 8 9

- 1 Keystone Technologies
- 2 LED Lamp
- 3 Wattage
- 4 Lamp Type
- 5 Nominal Length (Inches)
- 6 Glass Construction
- 7 800 Series
- 8 Color Temperature
- 9 Single- or Double-Ended Line Voltage and Ballast Compatible